

N1 to N3 DuraGalPlus[®] Domestic Construction Manual

Volume 3: DuraGalPlus RHS as floor beams
(bearers)

DuraGal **Plus**[®]



AustubeMills
SHAPING POSSIBILITIES

DuraGal[®] Domestic Construction Manual

- Volume 1: Roof beams - N1 to C3
 (N1 to C3 - Rafters)
 (N1 to N3 - Roof beams, strutting beams, roof battens, ceiling joists)
- Volume 2: Lintels - N1 to N3
 (Garage beams, window heads)
- Volume 3: Floor beams - N1 to N3
 (Bearers)

Foreword

This limited edition of the DuraGalPlus[®] Domestic Construction Manual has been prepared by Austube Mills based on the requirements of relevant Standards Australia and Industry specifications and in house testing.

The relevant design assumptions are listed in the front of each table.

Before selecting a member, reference should be made to the design assumptions to confirm the suitability of the tables for the intended applications.

Note: These tables do not take into account product availability from your steel distributor.

Please ensure that you check on product availability before you finalise the design.

Information on product availability can be obtained from the Austube Mills Product Availability Guide at www.austubemills.com.au.

It is strongly recommended that DuraGalPlus products be specified for construction when any of the design information in these manuals is used, as the calculations, including product tolerances, mechanical properties and chemical composition, have been validated by structural testing using only DuraGalPlus products. To ensure that the designers intentions are met it is strongly recommended that a note to this effect is included on any design information.

Letter of certification

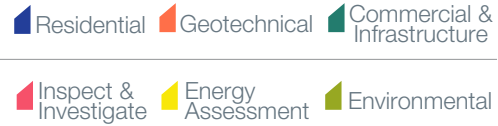

28 February 2017

Reference: 35739-16CS Vol3 ST01

Austube Mills
Industrial Drive
Newcastle NSW 2304

Dear Sir,

**Re: Structural Engineers Certification of
N1 to N3 DuraGalPlus Domestic Construction Manual
Volume 3: DuraGalPlus RHS as floor beams (bearers)
January 2017 Edition**

We hereby certify that we have checked the structural aspects of the span tables presented in the N1 to N3 DuraGalPlus Domestic Construction Manual Volume 3, dated January 2017.

We certify that the design tables conform to the requirements of the National Construction Code 2016 Building Code of Australia, and the following Australian Standards:

- AS/NZS 1170.0:2002 Structural design actions Part 0: General principles
- AS/NZS 1170.1:2002 Structural design actions Part 1: Permanent, imposed and other actions
- AS 4055:2012 Wind loads for housing
- NASH Standard: Residential and Low-rise Steel Framing Part 1: Design Criteria 2005
- AS 4100:1998 Steel Structures

These tables, when used within the parameters and limitations presented in this document, will provide structural solutions which satisfy the requirements of the National Construction Code 2016 Building Code of Australia and the referenced standards.

Yours faithfully
Structerre Consulting Engineers

Gervase Purich
BE FIEAust CPEng NPER RPEQ
CEO

WA | QLD | NSW | VIC

67 Links Ave North, Eagle Farm, Queensland 4009 PO Box 621, Hamilton, QLD 4007
Phone (+617) 3307 8300 | Fax (+617) 3307 8301 | Email brisbane@structerre.com.au | Web www.structerre.com.au
ABN 99 115 038 429 Structerre WBA Pty Ltd ACN 115 038 429 trading as Structerre Consulting Engineers (QLD)

fs-per/Directors/Correspondence/Gervase_Purich/2017/Duragal_Domestic_Construction/35739-16CS - Duragal Domestic Construction Manual Vol3 Certification 2017.02.27.docx Page 1 of 1

Contents	Page
Foreword	
Letter of certification	
DuraGalPlus product specifications	2
Span tables design data	3
DuraGalPlus RHS as bearer	5
How to use the tables	6
Example	8
Tables	
Bearer supporting floor only	10
Floor - timber	12
Floor - concrete	14
Bearer supporting floor and roof loads	16
Floor - timber	
Roof - masonry tiles and ceiling - pitched roof	18
Floor - timber	
Roof - masonry tiles and ceiling - trussed roof	20
Floor - timber	
Roof - steel sheeting and ceiling - pitched roof	22
Floor - timber	
Roof - steel sheeting and ceiling - trussed roof	24
Floor - concrete	
Roof - masonry tiles and ceiling - pitched roof	26
Floor - concrete	
Roof - masonry tiles and ceiling - trussed roof	28
Floor - concrete	
Roof - steel sheeting and ceiling - pitched roof	30
Floor - concrete	
Roof - steel sheeting and ceiling - trussed roof	32

DuraGalPlus[®] product specifications

Surface finish and corrosion protection

DuraGalPlus products are hot dip galvanized to section 3, AS/NZS 4792 with DuraGalPlus ZB100/100 having a minimum average coating mass of 100g/m² on each surface and DuraGalPlus ZB135/135 having 135g/m².

In many corrosive environments these systems may not require any additional surface treatment. In harsh environments additional top coats may need to be applied. For advice on painting systems for a wide range of environments refer to the 'DuraGal Easy Painting and Corrosion Protection Guide'.

Welding performance

DuraGalPlus sections are made from low carbon structural steel, so they are readily weldable. The zinc coating thickness is carefully controlled to ensure that structurally sound welds can be fabricated using standard welding practices. The 'DuraGal Easy Welding Guide' provides guidelines for welding DuraGalPlus products. The Guide can be found at www.austubemills.com.au/publications-and-resources/technical/duragal_easy_welding_guide.pdf.

Grade

DuraGalPlus sections are manufactured by a unique cold forming process which ensures the DuraGalPlus rectangular and square hollow sections (RHS/SHS) covered in this publication comply with the requirements of AS/NZS 1163 - C450LO. AS/NZS 1163 C450LO is supplied as C450PLUS, which meets AS/NZS 1163 requirements for both Grade 350LO and C450LO.

Designation

Typical designations for DuraGalPlus RHS and SHS are:

- > For DuraGalPlus RHS 150 x 50 x 4.0 RHS DuraGalPlus AS/NZS1163 C450LO supplied as C450PLUS
- > For DuraGalPlus SHS 100 x 100 x 4.0 RHS DuraGalPlus AS/NZS1163 C450LO supplied as C450PLUS

Length range

DuraGalPlus ZB100/100 is stocked by distributors in the following lengths.

Section	Size	Standard length (m)
RHS	50 x 25 to 75 x 25	8.0
	75 x 50 to 150 x 50	8.0 & 12.0
SHS	25 x 25	6.5
	30 x 30 to 65 x 65	8.0
	75 x 75 to 100 x 100	8.0 & 12.0

* Non-standard lengths - minimum order quantities and/or price extras may apply.

DuraGalPlus ZB135/135 is available in the following sizes in 8.0m lengths:

90 x 90 x 2.0	150 x 50 x 2.0
100 x 50 x 1.6	150 x 50 x 3.0
100 x 50 x 2.0	

More information on product availability can be found in the Product Availability Guide on Austube Mills website at www.austubemills.com.au.

Span tables design data

Scope

This volume of the DuraGal Domestic Construction Manual covers the design of DuraGalPlus RHS bearers which conform to wind classifications of up to category N3 .

The tables have been broadly divided into two sections: Bearers supporting floor loads only and bearers supporting floor and roof loads.

Design assumptions

The design assumptions used to generate these tables are as follows:

- > DuraGalPlus RHS bearers are designed in accordance with AS 4100.
- > All bearers are assumed to be restrained against lateral movement and twist along their lengths in accordance with AS 4100.
- > All applied loads are assumed to be uniformly distributed except for point live load requirements listed before each set of tables.
- > The loads applied and the deflection limits for each set of tables is shown before the tables.
- > All loads are static and applied vertically.
- > Minimum end and internal support bearing for bearers is assumed to be 70mm.
- > All bearers are assumed to be part of an enclosed building.
- > The wind pressure coefficients for enclosed buildings are taken as:
 - > External pressure coefficient, $C_{p,e}$ = -0.9
 - > Internal pressure coefficient, $C_{p,i}$ = +0.2 (for non-cyclonic areas)
 - > k_c = 0.9

[BLANK]

DuraGalPlus RHS as bearers

Examples of the use of DuraGalPlus members as bearers are shown in this section. The diagrams show DuraGalPlus RHS used as bearers supporting floor and roof loads and floor loads only.

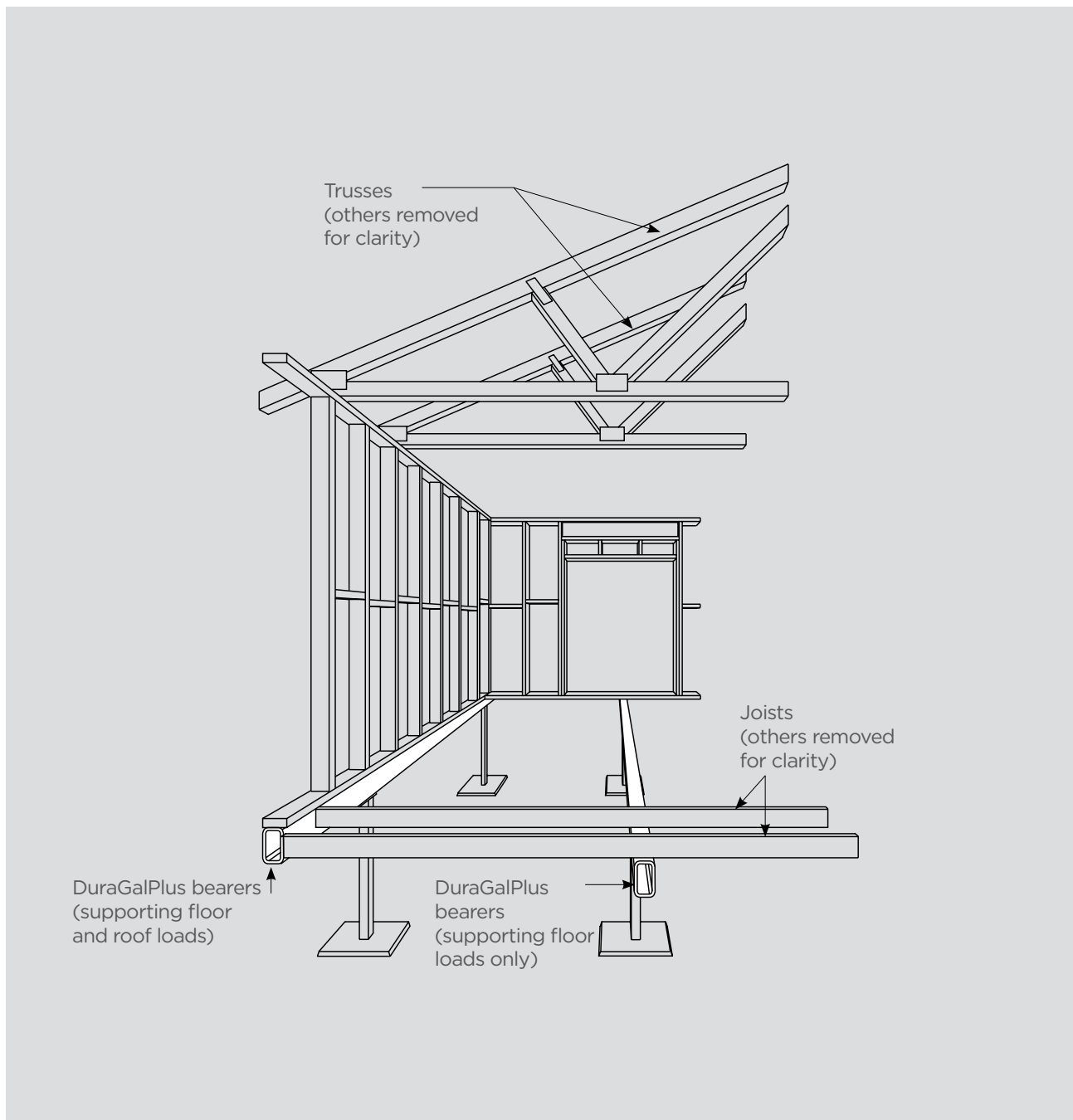

How to use the tables

Step 1

Find out if the bearer is carrying floor loads only or floor and roof loads.

Step 2

Establish the type of flooring material (timber or concrete).

Step 3

Check that the wind classification is equal to or below N3.

If bearer is carrying floor loads only go to Step 7

Step 4

Find the type of roofing material used (masonry tiles and ceiling or steel sheeting and ceiling).

Step 5

Establish if the roof is trussed or pitched.

Step 6

Calculate the effective floor width and effective roof width.

Step 7

Work out required effective bearer spacing as per the diagrams at the start of the tables.

Step 8

Work out the required span of the bearer. Check also if the bearer is single span or continuous span.

Step 9

Go to the appropriate table on the basis of information from Step 1 to 8.

Step 10

Select the column under effective bearer spacing with the table effective bearer spacing larger than or equal to the required effective bearer spacing (worked out in Step 7).

Step 11

Select the section that has a maximum span equal to or larger than the required span of bearer which is worked out in Step 8.

Floor - timber



Maximum bearer span (mm)

Continuous span

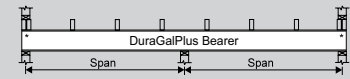

Effective Bearer 1 Spacing = $L_1 / 2$
Effective Bearer 2 Spacing = $L_1 / 2 + L_2$

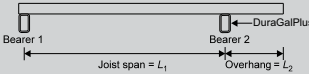

Effective Bearer 3 Spacing = $L_1 / 2$
Effective Bearer 4 Spacing = $0.625 \times (L_1 + L_2)$
Effective Bearer 5 Spacing = $L_2 / 2 + L_3$

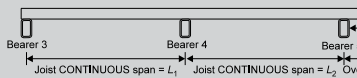

DuraGalPlus section	Mass kg/m	Effective Bearer Spacing (mm)							
		1800	2400	3000	3600	4200	4800	5400	6000
150x50x6.0RHS	16.7	4620	4200	3900	3670	3480	3330	3200	3090
150x50x5.0RHS	14.2	4430	4020	3730	3510	3340	3190	3070	2960
150x50x4.0RHS	11.6	4180	3800	3520	3320	3150	3010	2900	2800
150x50x3.0RHS	8.96	3880	3520	3270	3080	2860	2620	2420	2260
150x50x2.5RHS	7.53	3670	3260	2800	2470	2210*	2010*	1840*	1700*
150x50x2.0RHS	6.07	2740	2210*	1860*	1610*	1420*	1270*	1150*	1060*
125x75x6.0RHS	16.7	4330	3930	3650	3440	3270	3120	3000	2900
125x75x5.0RHS	14.2	4140	3760	3490	3290	3120	2990	2870	2770
125x75x4.0RHS	11.6	3910	3550	3290	3100	2950	2820	2710	2610
125x75x3.0RHS	8.96	3620	3290	3050	2870	2620	2420	2250	2110
125x75x2.5RHS	7.53	3430	2910	2540	2260	2050	1880	1740	1620
125x75x2.0RHS	6.07	2570	2120	1820*	1600*	1430*	1290*	1180*	1090*
100x50x5.0RHS	10.3	3100	2820	2620	2460	2340	2240	2150	2080
100x50x4.0RHS	8.49	2940	2670	2480	2340	2240	2120	2040	1970
100x50x3.5RHS	7.53	2850	2590	2400	2260	2150	2050	1970	1910
100x50x3.0RHS	6.60	2750	2500	2320	2180	2070	1980	1910	1840
100x50x2.5RHS	5.56	2610	2370	2200	2070	1970	1880	1800	1690
100x50x2.0RHS	4.50	2450	2220	2020	1800	1620	1480*	1370*	1270*
75x50x6.0RHS	16.7	4240	2200	2040	1920	1820	1750	1680	1620
75x50x5.0RHS	14.2	4080	2100	1950	1830	1740	1660	1600	1550
75x50x4.0RHS	11.6	3820	2170	1970	1830	1720	1630	1560	1500
75x50x3.0RHS	8.96	3580	2060	1870	1740	1640	1560	1490	1430
75x50x2.5RHS	7.53	3220	1940	1760	1630	1540	1460	1400	1320
75x50x2.0RHS	6.07	2810	1810	1630	1420	1260	1140*	1050*	970*
75x50x1.6RHS	5.00	2650	1710	1540	1340	1180	1070	1000	940



Floor - concrete (max. floor thickness 125mm)
Roof - masonry tiles and ceiling - pitched roof^{*1}

Maximum bearer span (mm)

Single span

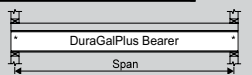

DuraGalPlus section	Mass kg/m	Effective Bearer Spacing (mm)							
		1800	2400	3000	3600	4200	4800	5400	6000
150x50x6.0RHS	16.7	3260	2970	2760	2590	2470	2360	2270	2190
150x50x5.0RHS	14.2	3120	2840	2640	2490	2360	2260	2170	2100
150x50x4.0RHS	11.6	2950	2680	2490	2350	2230	2130	2050	1980
150x50x3.0RHS	8.96	2740	2490	2310	2180	2070*	1980*	1900*	1840*
150x50x2.5RHS	7.53	2600	2360*	2190*	1980*	1700*	1490*	1320*	1190*
150x50x2.0RHS	6.07	2010*	1510*	1210*	1010*	860*	760*	670*	600*
125x75x6.0RHS	16.7	3050	2780	2580	2430	2310	2210	2130	2050
125x75x5.0RHS	14.2	2920	2660	2470	2330	2210	2110	2030	1960
125x75x4.0RHS	11.6	2760	2510	2330	2190	2090	1990	1920	1850
125x75x3.0RHS	8.96	2560	2330	2160	2030	1930	1850	1780	1720
125x75x2.5RHS	7.53	2430	2210	2050	1930*	1830*	1750*	1650*	1570*
125x75x2.0RHS	6.07	2270*	1990*	1590*	1330*	1140*	1000*	890*	800*
100x50x5.0RHS	10.3	2190	1990	1850	1740	1660	1580	1520	1470
100x50x4.0RHS	8.49	2080	1890	1760	1650	1570	1500	1450	1400
100x50x3.5RHS	7.53	2010	1830	1700	1600	1520	1450	1400	1350
100x50x3.0RHS	6.60	1950	1770	1640	1550	1470	1400	1350	1300
100x50x2.5RHS	5.56	1850	1680	1560	1470	1400	1330	1280	1240*
100x50x2.0RHS	4.50	1730	1570	1460*	1380*	1310*	1250*	1200*	1130*
75x50x5.0RHS	8.35	1710	1560	1450	1360	1290	1240	1190	1150
75x50x4.0RHS	6.92	1630	1480	1380	1300	1230	1180	1130	1100
75x50x3.0RHS	5.42	1530	1390	1300	1220	1160	1110	1070	1030
75x50x2.5RHS	4.58	1460	1330	1230	1160	1100	1050	1010	980
75x50x2.0RHS	3.72	1370	1250	1160	1090	1030	990	950	910*
75x50x1.6RHS	3.01	1280	1170	1080*	990*	910*	850*	810*	760*

^{*1} If load bearing walls perpendicular to the bearer are supported at the end of the bearer (e.g. 2.1m of masonry tile roof and weight of the load bearing wall)

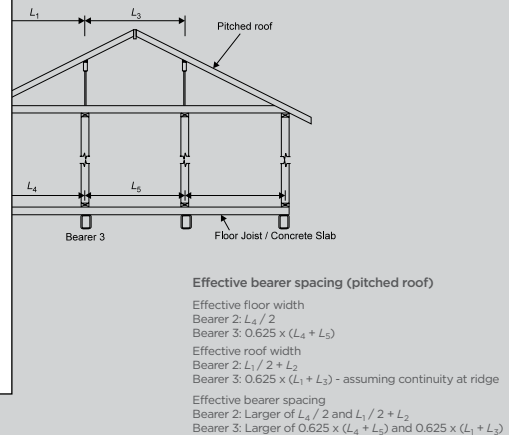
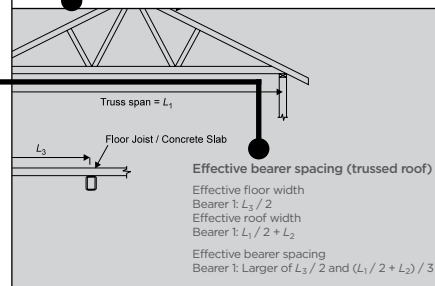

^{*1} Pitched roof - effective roof width is assumed to be equal to effective floor width
* Additional web stiffeners are required if load bearing walls perpendicular to the bearer are supported at the end of the bearer (load from cross wall is assumed to be 2.1m of masonry tile roof and weight of the load bearing wall)

N1 to N3 - DuraGalPlus[®] RHS as floor beams - bearers
DDCM Volume 3 - January 2017

Example

Size a bearer supporting timber floor and a load bearing wall carrying masonry tiled (and ceiling) trussed roof. The effective load widths are shown below. The bearer has a continuous span of 3500mm. The wind classification is given as N3.

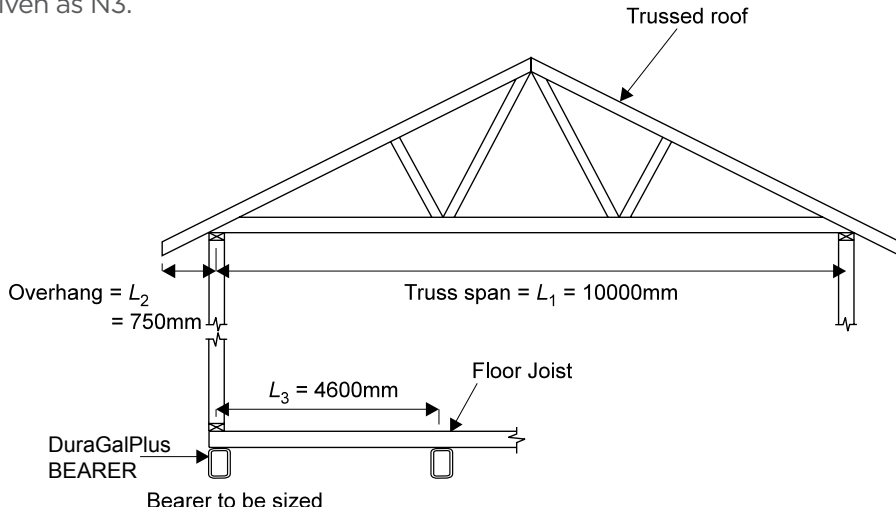

Step 1: Bearer is carrying floor and roof loads

Step 2: Floor - timber

Step 3: Wind classification is N3

Step 4: Roof - masonry tiles and ceiling

Step 5: Roof - trussed

Step 6: Effective floor width = $4600 / 2 = 2300\text{mm}$
 Effective roof width = $10000 / 2 + 750 = 5750\text{mm}$

Step 7: Required bearer spacing (refer to page 17)
 = Larger of 2300mm and $5750 / 3 (= 1917\text{mm})$

= 2300mm

Step 8: Required Bearer Span

= 3500mm (continuous)

Step 9: Select appropriate table

Step 10: Select column with Effective bearer spacing

$\geq 2300\text{mm}$

Step 11: Select 150x50x5 RHS DuraGalPlus (mass = 14.2kg/m) Maximum span

= 3690mm > 3500mm

● Floor - timber
● Roof - masonry tiles and ceiling - trussed roof*

DuraGal^{Plus}

Maximum bearer span (mm)

Continuous span

DuraGalPlus section	Mass kg/m	Effective Bearer Spacing (mm)							
		1800	2400	3000	3600	4200	4800	5400	6000
150x50x6.0RHS	16.7	4230	3850	3560	3250	3010	2820	2660	2510
150x50x5.0RHS	14.2	4060	3310	3030	2800	2580	2400	2400	2440
150x50x3.0RHS	11.6	3840	2860	2570	2340	2160	2010	1880	1880
150x50x2.5RHS	8.96	2900	2400	2070	1820	1640	1490	1360	1260
150x50x2.0RHS	7.53	2250	1820	1540	1340	1180	1060	940	850
150x50x1.6RHS	6.07	1430	1070	860	720	610	540	480	430
125x75x6.0RHS	16.7	3970	3610	3360	3060	2800	2590	2420	2280
125x75x5.0RHS	14.2	3800	3460	3080	2780	2530	2340	2180	2050
125x75x4.0RHS	11.6	3590	3100	2720	2440	2220	2050	1900	1780
125x75x3.0RHS	8.96	2660	2230	1940	1730	1570	1440	1330	1240
125x75x2.5RHS	7.53	2080	1720	1480	1300	1170	1060	970	900
125x75x2.0RHS	6.07	1450	1170	990	860	760	680	610	550
100x50x5.0RHS	10.3	2850	2590	2360	2150	1990	1860	1760	1660
100x50x4.0RHS	8.49	2710	2410	2160	1970	1810	1670	1560	1460
100x50x3.5RHS	7.53	2620	2290	2050	1840	1680	1540	1430	1340
100x50x3.0RHS	6.60	2490	2110	1860	1670	1520	1400	1310	1220
100x50x2.5RHS	5.56	2130	1790	1560	1390	1250	1150	1060	990
100x50x2.0RHS	4.50	1650	1350	1160	1020	910	820	750	690
75x50x5.0RHS	8.35	2230	2020	1870	1700	1580	1480	1390	1320
75x50x4.0RHS	6.92	2120	1920	1720	1570	1450	1360	1270	1200
75x50x3.0RHS	5.42	1990	1730	1550	1410	1310	1220	1130	1060
75x50x2.5RHS	4.58	1840	1600	1430	1300	1180	1090	1010	950
75x50x2.0RHS	3.72	1550	1310	1140	1020	920	850	780	730
75x50x1.6RHS	3.01	1160	960	820	730	650	590	540	500

Supporting floor and roof loads

¹ Trussed roof - effective roof width is assumed to be equal to 3 times effective floor width

* Additional web stiffeners are required if load bearing walls perpendicular to the bearer are supported at the end of the bearer (load from cross wall is assumed to be 2.1m of masonry tile roof and weight of the load bearing wall)

N1 to N3 - DuraGalPlus[®] RHS as floor beams - bearers
DDCM Volume 3 - January 2017

Bearers supporting floor only

Applied loads and deflection limits used to generate the tables on pages 12 to 15.

Floor	Load (kPa)		Deflection (mm)	
	Dead load (G)	Live load (Q)	Dead and live load (G + 0.4Q with Q = 1.5kPa)	Live load (Q = 1.5kPa)
Timber floor with non-load bearing walls	0.9	Larger of 1.5 and	Span / 250 or 12mm	Span / 550 or 12mm
Concrete floor with non-load bearing walls	3.4	3.75 / area + 0.25 but less than 4.0		

Effective Bearer 1 Spacing = $L_1 / 2$
 Effective Bearer 2 Spacing = $L_1 / 2 + L_2$

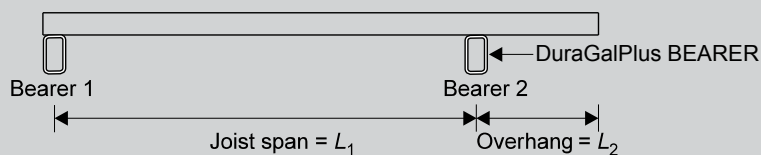

Effective Bearer 3 Spacing = $L_1 / 2$
 Effective Bearer 4 Spacing = $0.625 \times (L_1 + L_2)$
 Effective Bearer 5 Spacing = $L_2 / 2 + L_3$

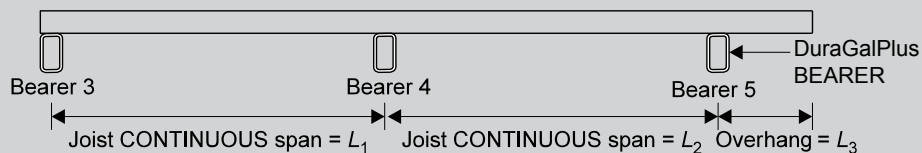

Typical connection details

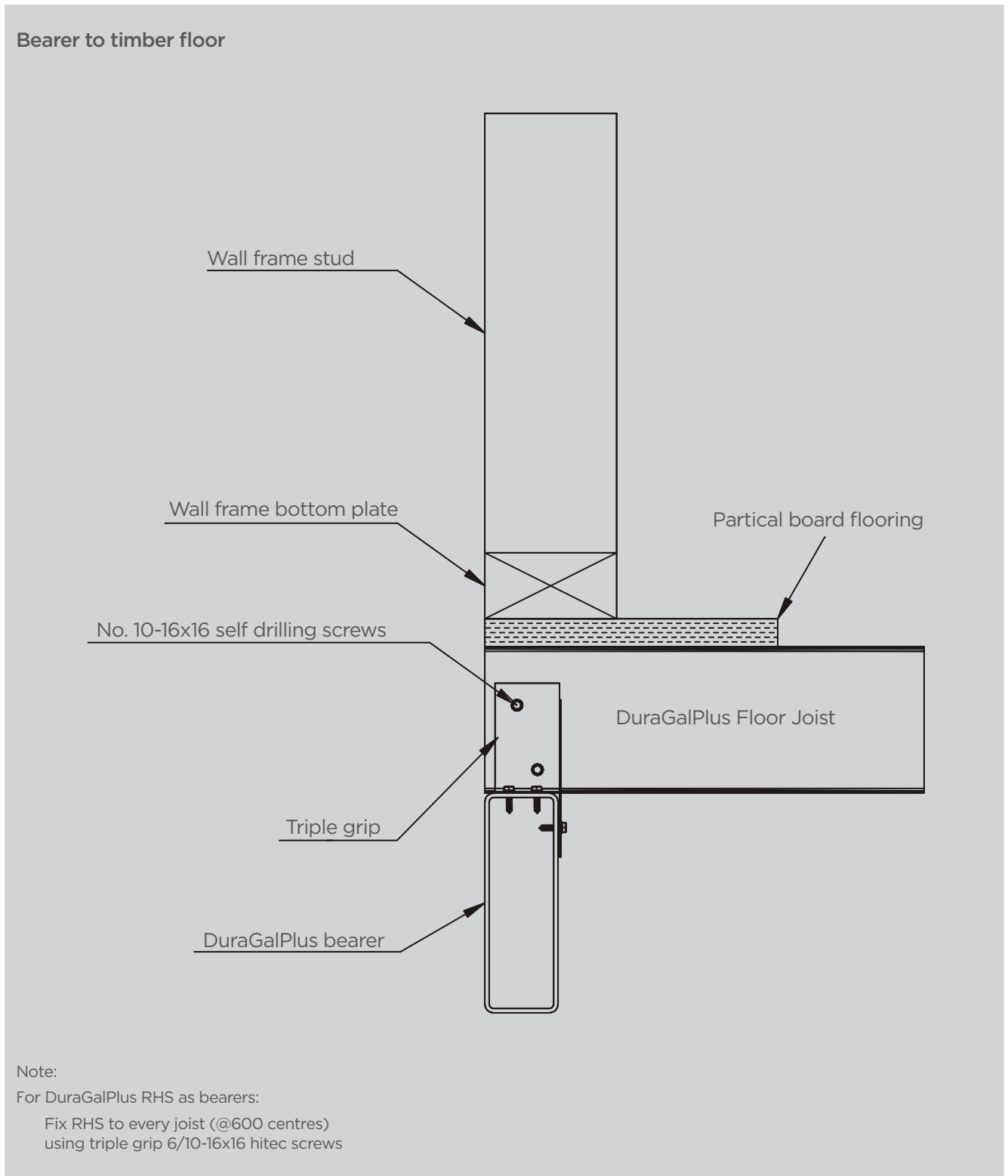

Maximum bearer span (mm)

Single span

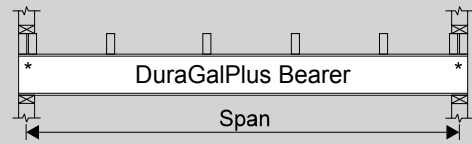

DuraGalPlus section	Mass kg/m	Effective Bearer Spacing (mm)							
		1800	2400	3000	3600	4200	4800	5400	6000
150x50x6.0RHS	16.7	3740	3400	3150	2970	2820	2700	2590	2500
150x50x5.0RHS	14.2	3580	3250	3020	2840	2700	2580	2480	2400
150x50x4.0RHS	11.6	3380	3070	2850	2680	2550	2440	2340	2260
150x50x3.0RHS	8.96	3140	2850	2650	2490	2370	2260	2180	2100
150x50x2.5RHS	7.53	2970	2700	2510	2360*	2240*	2140*	2060*	1990*
150x50x2.0RHS	6.07	2780*	2530*	2340*	2210*	1950*	1700*	1510*	1360*
125x75x6.0RHS	16.7	3500	3180	2960	2780	2640	2530	2430	2350
125x75x5.0RHS	14.2	3350	3050	2830	2660	2530	2420	2320	2240
125x75x4.0RHS	11.6	3160	2870	2670	2510	2380	2280	2190	2120
125x75x3.0RHS	8.96	2930	2660	2470	2320	2210	2110	2030	1960
125x75x2.5RHS	7.53	2770	2520	2340	2200	2090	2000	1920*	1860*
125x75x2.0RHS	6.07	2590	2360*	2190*	2060*	1950*	1870*	1800*	1740*
100x50x5.0RHS	10.3	2510	2280	2120	1990	1890	1810	1740	1680
100x50x4.0RHS	8.49	2380	2160	2010	1890	1800	1720	1650	1590
100x50x3.5RHS	7.53	2300	2090	1940	1830	1740	1660	1600	1540
100x50x3.0RHS	6.60	2220	2020	1880	1770	1680	1600	1540	1490
100x50x2.5RHS	5.56	2110	1920	1780	1680	1590	1520	1470	1410
100x50x2.0RHS	4.50	1980	1800	1670	1570	1490*	1430*	1370*	1330*
75x50x5.0RHS	8.35	1960	1780	1650	1550	1480	1410	1360	1310
75x50x4.0RHS	6.92	1870	1700	1580	1480	1410	1350	1300	1250
75x50x3.0RHS	5.42	1750	1590	1480	1390	1320	1260	1220	1170
75x50x2.5RHS	4.58	1670	1520	1410	1320	1260	1200	1160	1120
75x50x2.0RHS	3.72	1570	1420	1320	1240	1180	1130	1090	1050
75x50x1.6RHS	3.01	1470	1330	1240	1160	1110*	1060*	1020*	980*

* Additional web stiffeners are required if load bearing walls perpendicular to the bearer are supported at the end of the bearer (load from cross wall is assumed to be 2.1m of masonry tile roof and weight of the load bearing wall)

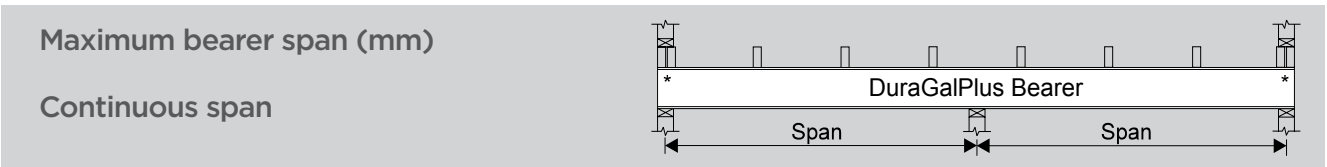

DuraGalPlus section	Mass kg/m	Effective Bearer Spacing (mm)							
		1800	2400	3000	3600	4200	4800	5400	6000
150x50x6.0RHS	16.7	4620	4200	3900	3670	3480	3330	3200	3090
150x50x5.0RHS	14.2	4430	4020	3730	3510	3340	3190	3070	2960
150x50x4.0RHS	11.6	4180	3800	3520	3320	3150	3010	2900	2800
150x50x3.0RHS	8.96	3880	3520	3270	3080	2860	2620	2420	2260
150x50x2.5RHS	7.53	3670	3260	2800	2470	2210*	2010*	1840*	1700*
150x50x2.0RHS	6.07	2740	2210*	1860*	1610*	1420*	1270*	1150*	1060*
125x75x6.0RHS	16.7	4330	3930	3650	3440	3270	3120	3000	2900
125x75x5.0RHS	14.2	4140	3760	3490	3290	3120	2990	2870	2770
125x75x4.0RHS	11.6	3910	3550	3290	3100	2950	2820	2710	2610
125x75x3.0RHS	8.96	3620	3290	3050	2870	2620	2420	2250	2110
125x75x2.5RHS	7.53	3430	2910	2540	2260	2050	1880	1740	1620
125x75x2.0RHS	6.07	2570	2120	1820*	1600*	1430*	1290*	1180*	1090*
100x50x5.0RHS	10.3	3100	2820	2620	2460	2340	2240	2150	2080
100x50x4.0RHS	8.49	2940	2670	2480	2340	2220	2120	2040	1970
100x50x3.5RHS	7.53	2850	2590	2400	2260	2150	2050	1970	1910
100x50x3.0RHS	6.60	2750	2500	2320	2180	2070	1980	1910	1840
100x50x2.5RHS	5.56	2610	2370	2200	2070	1970	1880	1800	1690
100x50x2.0RHS	4.50	2450	2220	2020	1800	1620	1480*	1370*	1270*
75x50x5.0RHS	8.35	2420	2200	2040	1920	1820	1750	1680	1620
75x50x4.0RHS	6.92	2310	2100	1950	1830	1740	1660	1600	1550
75x50x3.0RHS	5.42	2170	1970	1830	1720	1630	1560	1500	1450
75x50x2.5RHS	4.58	2060	1870	1740	1640	1560	1490	1430	1380
75x50x2.0RHS	3.72	1940	1760	1630	1540	1460	1400	1320	1240
75x50x1.6RHS	3.01	1810	1630	1420	1260	1140*	1050*	970*	900*

* Additional web stiffeners are required if load bearing walls perpendicular to the bearer are supported at the end of the bearer (load from cross wall is assumed to be 2.1m of masonry tile roof and weight of the load bearing wall)

Maximum bearer span (mm)

Single span

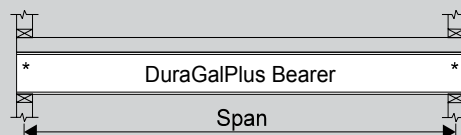

DuraGalPlus section	Mass kg/m	Effective Bearer Spacing (mm)							
		1800	2400	3000	3600	4200	4800	5400	6000
150x50x6.0RHS	16.7	3480	3170	2950	2770	2640	2520	2430	2340
150x50x5.0RHS	14.2	3340	3040	2820	2660	2530	2420	2320	2240
150x50x4.0RHS	11.6	3150	2870	2670	2510	2390	2280	2190	2120
150x50x3.0RHS	8.96	2930	2670	2480	2330	2210	2120*	2040*	1970*
150x50x2.5RHS	7.53	2780	2530*	2350*	2210*	1990*	1750*	1550*	1400*
150x50x2.0RHS	6.07	2350*	1770*	1420*	1180*	1010*	890*	790*	710*
125x75x6.0RHS	16.7	3260	2970	2760	2600	2470	2360	2270	2200
125x75x5.0RHS	14.2	3120	2840	2640	2490	2360	2260	2170	2100
125x75x4.0RHS	11.6	2950	2680	2490	2350	2230	2130	2050	1980
125x75x3.0RHS	8.96	2740	2490	2310	2180	2070	1980	1900	1840
125x75x2.5RHS	7.53	2590	2360	2190	2060*	1960*	1870*	1790*	1700*
125x75x2.0RHS	6.07	2430*	2210*	1870*	1560*	1340*	1170*	1040*	940*
100x50x5.0RHS	10.3	2340	2130	1980	1860	1770	1690	1630	1570
100x50x4.0RHS	8.49	2230	2020	1880	1770	1680	1610	1550	1490
100x50x3.5RHS	7.53	2150	1960	1820	1710	1630	1560	1500	1440
100x50x3.0RHS	6.60	2080	1890	1760	1650	1570	1500	1450	1400
100x50x2.5RHS	5.56	1980	1800	1670	1570	1490	1430	1370	1330
100x50x2.0RHS	4.50	1850	1680	1560*	1470*	1400*	1340*	1290*	1230*
75x50x5.0RHS	8.35	1830	1660	1550	1460	1380	1320	1270	1230
75x50x4.0RHS	6.92	1750	1590	1470	1390	1320	1260	1210	1170
75x50x3.0RHS	5.42	1640	1490	1390	1300	1240	1190	1140	1100
75x50x2.5RHS	4.58	1560	1420	1320	1240	1180	1130	1080	1050
75x50x2.0RHS	3.72	1470	1330	1240	1170	1110	1060	1020	980*
75x50x1.6RHS	3.01	1370	1250	1160*	1070*	990*	930*	870*	830*

* Additional web stiffeners are required if load bearing walls perpendicular to the bearer are supported at the end of the bearer (load from cross wall is assumed to be 2.1m of masonry tile roof and weight of the load bearing wall)

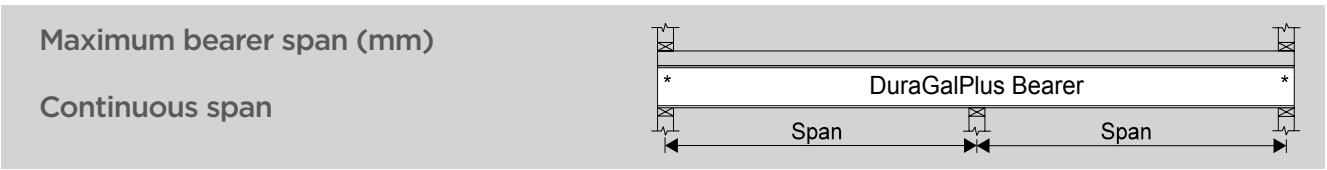

DuraGalPlus section	Mass kg/m	Effective Bearer Spacing (mm)							
		1800	2400	3000	3600	4200	4800	5400	6000
150x50x6.0RHS	16.7	4300	3920	3640	3430	3260	3070	2890	2740
150x50x5.0RHS	14.2	4120	3750	3490	3280	3050	2850	2660	2500
150x50x4.0RHS	11.6	3900	3550	3160	2840	2590	2390	2230	2090
150x50x3.0RHS	8.96	3230	2680	2320	2050	1840	1680	1540	1430
150x50x2.5RHS	7.53	2530	2060	1750	1520*	1350*	1220*	1110*	1020*
150x50x2.0RHS	6.07	1660*	1310*	1090*	930*	820*	730*	650*	590*
125x75x6.0RHS	16.7	4030	3670	3410	3210	3050	2860	2670	2510
125x75x5.0RHS	14.2	3860	3510	3260	3060	2800	2590	2410	2270
125x75x4.0RHS	11.6	3640	3320	3010	2700	2460	2270	2110	1980
125x75x3.0RHS	8.96	2940	2480	2160	1930	1750	1600	1480	1380
125x75x2.5RHS	7.53	2320	1920	1660	1470	1320	1200	1100	1020*
125x75x2.0RHS	6.07	1630	1330	1130*	980*	870*	780*	710*	650*
100x50x5.0RHS	10.3	2890	2630	2450	2300	2170	2030	1910	1810
100x50x4.0RHS	8.49	2750	2500	2320	2150	1990	1850	1720	1620
100x50x3.5RHS	7.53	2660	2420	2230	2030	1860	1710	1590	1490
100x50x3.0RHS	6.60	2570	2320	2050	1840	1680	1550	1450	1360
100x50x2.5RHS	5.56	2350	1980	1730	1540	1400	1290	1190	1110
100x50x2.0RHS	4.50	1840	1520	1300	1150	1030*	930*	850*	790*
75x50x5.0RHS	8.35	2260	2060	1910	1800	1710	1610	1510	1440
75x50x4.0RHS	6.92	2160	1960	1820	1710	1580	1480	1400	1320
75x50x3.0RHS	5.42	2030	1840	1680	1540	1420	1330	1250	1180
75x50x2.5RHS	4.58	1930	1740	1550	1420	1310	1210	1130	1060
75x50x2.0RHS	3.72	1720	1450	1270	1130	1030	940	870	820
75x50x1.6RHS	3.01	1210	1030	910	810*	730*	670*	610*	570*

* Additional web stiffeners are required if load bearing walls perpendicular to the bearer are supported at the end of the bearer (load from cross wall is assumed to be 2.1m of masonry tile roof and weight of the load bearing wall)

Bearers supporting floor and roof loads

Applied loads and deflection limits used to generate the tables on pages 18 to 33.

	Load (kPa)		Deflection (mm)	
	Dead load (G)	Live load (Q)	Dead and live load (G + 0.4Q with Q = 1.5kPa)	Live load (Q = 1.5kPa)
Flooring				
Timber floor with non-load bearing walls	0.9			
Concrete floor with non-load bearing walls	3.4	Larger of 1.5 and 3.75 / area + 0.25 but less than 4.0	Span / 250	Span / 550
Roofing				
Masonry tiles and ceiling	0.9			
Steel sheeting and ceiling	0.4			

* Maximum concrete floor thickness assumed to be 125mm

Typical Connection Details

Connection details for bearers supporting floor and roof loads are similar to the connection details for bearers supporting floor loads only as shown on page 11.

Bearer supporting floor and roof loads

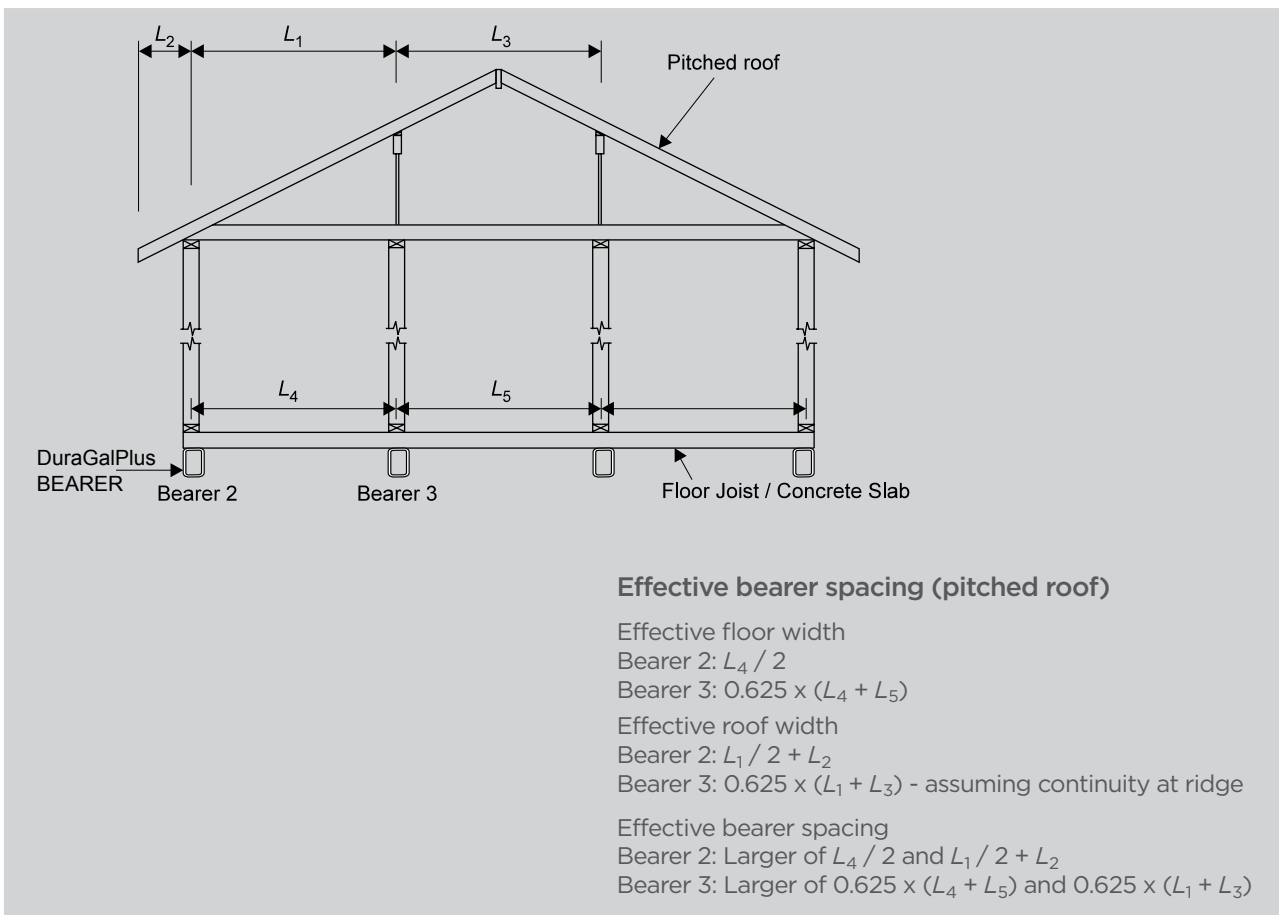
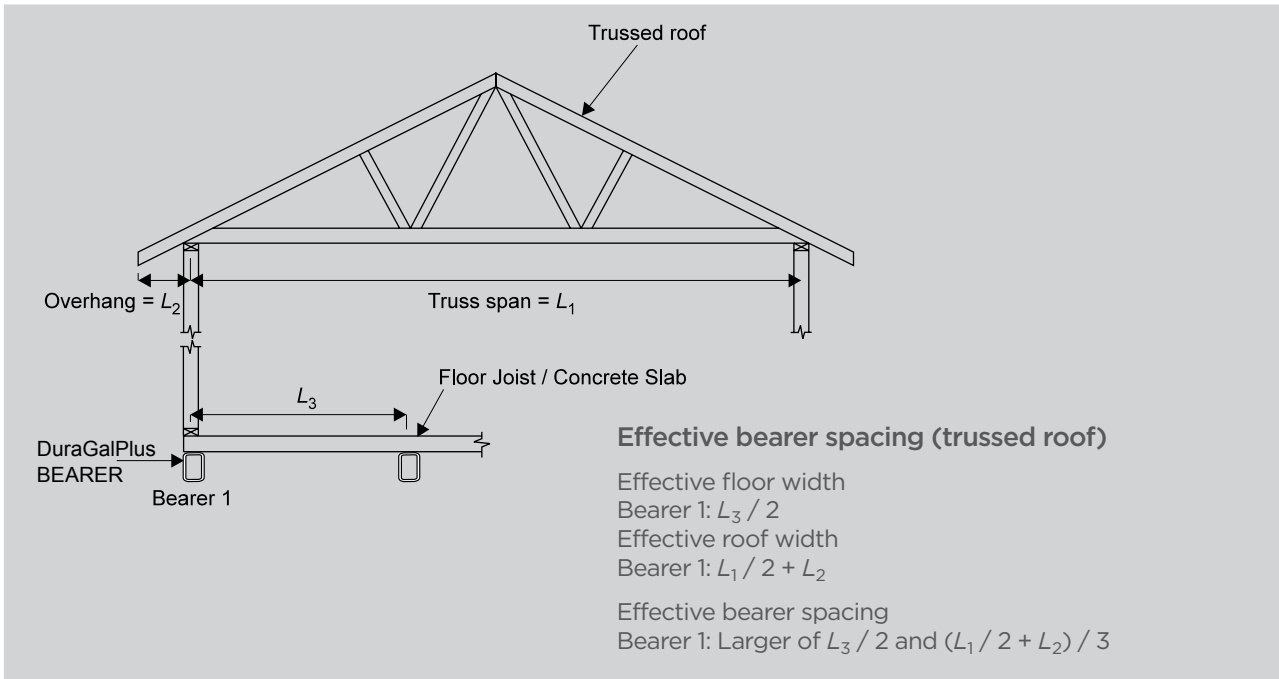

Maximum bearer span (mm)

Single span

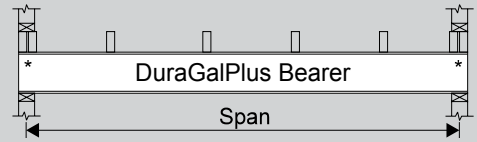

DuraGalPlus section	Mass kg/m	Effective Bearer Spacing (mm)							
		1800	2400	3000	3600	4200	4800	5400	6000
150x50x6.0RHS	16.7	3740	3400	3150	2970	2820	2700	2590	2500
150x50x5.0RHS	14.2	3580	3250	3020	2840	2700	2580	2480	2400
150x50x4.0RHS	11.6	3380	3070	2850	2680	2550	2440	2340	2260
150x50x3.0RHS	8.96	3140	2850	2650	2490	2370	2260	2180	2100*
150x50x2.5RHS	7.53	2970	2700	2510*	2360*	2240*	2140*	2060*	1990*
150x50x2.0RHS	6.07	2780*	2530*	2040*	1700*	1460*	1280*	1140*	1020*
125x75x6.0RHS	16.7	3500	3180	2960	2780	2640	2530	2430	2350
125x75x5.0RHS	14.2	3350	3050	2830	2660	2530	2420	2320	2240
125x75x4.0RHS	11.6	3160	2870	2670	2510	2380	2280	2190	2120
125x75x3.0RHS	8.96	2930	2660	2470	2320	2210	2110	2030	1960
125x75x2.5RHS	7.53	2770	2520	2340	2200	2090	2000*	1920*	1860*
125x75x2.0RHS	6.07	2590	2360*	2190*	2060*	1930*	1690*	1500*	1350*
100x50x5.0RHS	10.3	2510	2280	2120	1990	1890	1810	1740	1680
100x50x4.0RHS	8.49	2380	2160	2010	1890	1800	1720	1650	1590
100x50x3.5RHS	7.53	2300	2090	1940	1830	1740	1660	1600	1540
100x50x3.0RHS	6.60	2220	2020	1880	1770	1680	1600	1540	1490
100x50x2.5RHS	5.56	2110	1920	1780	1680	1590	1520	1470	1410
100x50x2.0RHS	4.50	1980	1800	1670	1570*	1490*	1430*	1370*	1330*
75x50x5.0RHS	8.35	1960	1780	1650	1550	1480	1410	1360	1310
75x50x4.0RHS	6.92	1870	1700	1580	1480	1410	1350	1300	1250
75x50x3.0RHS	5.42	1750	1590	1480	1390	1320	1260	1220	1170
75x50x2.5RHS	4.58	1670	1520	1410	1320	1260	1200	1160	1120
75x50x2.0RHS	3.72	1570	1420	1320	1240	1180	1130	1090	1050
75x50x1.6RHS	3.01	1470	1330	1240	1160*	1110*	1060*	1020*	980*

*1 Pitched roof - effective roof width is assumed to be equal to effective floor width

* Additional web stiffeners are required if load bearing walls perpendicular to the bearer are supported at the end of the bearer (load from cross wall is assumed to be 2.1m of masonry tile roof and weight of the load bearing wall)

Maximum bearer span (mm)

Continuous span

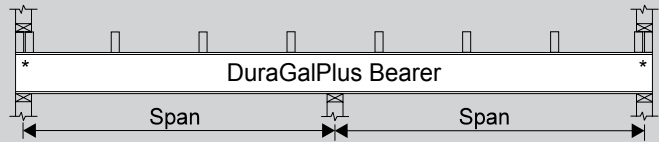

DuraGalPlus section	Mass kg/m	Effective Bearer Spacing (mm)							
		1800	2400	3000	3600	4200	4800	5400	6000
150x50x6.0RHS	16.7	4620	4200	3900	3670	3480	3330	3200	3090
150x50x5.0RHS	14.2	4430	4020	3730	3510	3340	3190	3070	2960
150x50x4.0RHS	11.6	4180	3800	3520	3320	3150	2980	2780	2610
150x50x3.0RHS	8.96	3880	3400	2950	2620	2370	2160	2000	1860
150x50x2.5RHS	7.53	3260	2680	2290	2010	1790*	1620*	1480*	1360*
150x50x2.0RHS	6.07	2210*	1770*	1480*	1270*	1120*	1000*	900*	820*
125x75x6.0RHS	16.7	4330	3930	3650	3440	3270	3120	3000	2900
125x75x5.0RHS	14.2	4140	3760	3490	3290	3120	2990	2870	2770
125x75x4.0RHS	11.6	3910	3550	3290	3100	2950	2820	2640	2480
125x75x3.0RHS	8.96	3620	3080	2700	2420	2200	2030	1880	1760
125x75x2.5RHS	7.53	2910	2440	2110	1880	1690	1550	1430	1330*
125x75x2.0RHS	6.07	2120	1740	1480*	1290*	1150*	1040*	950*	870*
100x50x5.0RHS	10.3	3100	2820	2620	2460	2340	2240	2150	2080
100x50x4.0RHS	8.49	2940	2670	2480	2340	2220	2120	2040	1970
100x50x3.5RHS	7.53	2850	2590	2400	2260	2150	2050	1970	1870
100x50x3.0RHS	6.60	2750	2500	2320	2180	2070	1930	1800	1690
100x50x2.5RHS	5.56	2610	2370	2160	1940	1760	1620	1510	1410
100x50x2.0RHS	4.50	2330	1940	1680	1480	1330	1210*	1120*	1040*
75x50x5.0RHS	8.35	2420	2200	2040	1920	1820	1750	1680	1620
75x50x4.0RHS	6.92	2310	2100	1950	1830	1740	1660	1600	1550
75x50x3.0RHS	5.42	2170	1970	1830	1720	1630	1560	1500	1430
75x50x2.5RHS	4.58	2060	1870	1740	1640	1560	1480	1390	1320
75x50x2.0RHS	3.72	1940	1760	1580	1420	1290	1190	1100	1030
75x50x1.6RHS	3.01	1610	1360	1180	1050	940*	860*	790*	740*

*1 Pitched roof - effective roof width is assumed to be equal to effective floor width

* Additional web stiffeners are required if load bearing walls perpendicular to the bearer are supported at the end of the bearer (load from cross wall is assumed to be 2.1m of masonry tile roof and weight of the load bearing wall)

Maximum bearer span (mm)

Single span

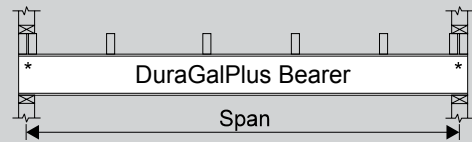

DuraGalPlus section	Mass kg/m	Effective Bearer Spacing (mm)							
		1800	2400	3000	3600	4200	4800	5400	6000
150x50x6.0RHS	16.7	3430	3120	2900	2730	2590	2480	2390	2310
150x50x5.0RHS	14.2	3280	2990	2780	2610	2490	2380	2290	2210
150x50x4.0RHS	11.6	3100	2820	2620	2470	2350	2250	2160	2090
150x50x3.0RHS	8.96	2880	2620	2440	2290	2180	2080*	2000*	1940*
150x50x2.5RHS	7.53	2730	2490*	2310*	2170*	1920*	1680*	1500*	1350*
150x50x2.0RHS	6.07	2270*	1700*	1360*	1140*	980*	850*	760*	680*
125x75x6.0RHS	16.7	3210	2920	2720	2560	2430	2330	2240	2160
125x75x5.0RHS	14.2	3070	2800	2600	2450	2330	2230	2140	2070
125x75x4.0RHS	11.6	2900	2640	2450	2310	2190	2100	2020	1950
125x75x3.0RHS	8.96	2690	2450	2270	2140	2030	1950	1870	1810
125x75x2.5RHS	7.53	2550	2320	2160	2030*	1930*	1840*	1750*	1660*
125x75x2.0RHS	6.07	2390*	2170*	1800*	1500*	1290*	1130*	1000*	900*
100x50x5.0RHS	10.3	2310	2100	1950	1830	1740	1670	1600	1550
100x50x4.0RHS	8.49	2190	1990	1850	1740	1650	1580	1520	1470
100x50x3.5RHS	7.53	2120	1930	1790	1680	1600	1530	1470	1420
100x50x3.0RHS	6.60	2050	1860	1730	1630	1550	1480	1420	1370
100x50x2.5RHS	5.56	1950	1770	1640	1550	1470	1400	1350	1300
100x50x2.0RHS	4.50	1820	1660	1540*	1450*	1380*	1320*	1270*	1210*
75x50x5.0RHS	8.35	1800	1640	1520	1430	1360	1300	1250	1210
75x50x4.0RHS	6.92	1720	1560	1450	1370	1300	1240	1190	1150
75x50x3.0RHS	5.42	1610	1470	1360	1280	1220	1170	1120	1080
75x50x2.5RHS	4.58	1540	1400	1300	1220	1160	1110	1070	1030
75x50x2.0RHS	3.72	1440	1310	1220	1150	1090	1040	1000	970*
75x50x1.6RHS	3.01	1350	1230	1140*	1050*	970*	910*	860*	810*

*1 Trussed roof - effective roof width is assumed to be equal to 3 times effective floor width

* Additional web stiffeners are required if load bearing walls perpendicular to the bearer are supported at the end of the bearer (load from cross wall is assumed to be 2.1m of masonry tile roof and weight of the load bearing wall)

Maximum bearer span (mm)

Continuous span

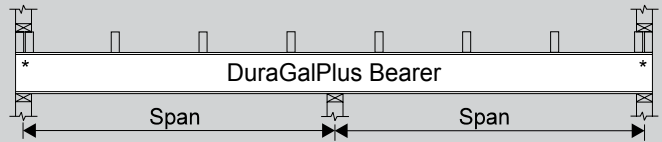

DuraGalPlus section	Mass kg/m	Effective Bearer Spacing (mm)								
		1800	2400	3000	3600	4200	4800	5400	6000	
150x50x6.0RHS	16.7	4230	3850	3560	3250	3010	2820	2660	2510	
150x50x5.0RHS	14.2	4060	3690	3310	3030	2800	2580	2400	2440	
150x50x4.0RHS	11.6	3840	3260	2860	2570	2340	2160	2010	1880	
150x50x3.0RHS	8.96	2900	2400	2070	1820	1640	1490	1360	1260	
150x50x2.5RHS	7.53	2250	1820	1540	1340	1180	1060	940	850	
150x50x2.0RHS	6.07	1430	1070	860	720	610	540	480	430	
125x75x6.0RHS	16.7	3970	3610	3360	3060	2800	2590	2420	2280	
125x75x5.0RHS	14.2	3800	3460	3080	2780	2530	2340	2180	2050	
125x75x4.0RHS	11.6	3590	3100	2720	2440	2220	2050	1000	1780	
125x75x3.0RHS	8.96	2660	2230	1940	1730	1570	1440	1330	1240	
125x75x2.5RHS	7.53	2080	1720	1480	1300	1170	1060	970	900	
125x75x2.0RHS	6.07	1450	1170	990	860	760	680	610	550	
100x50x5.0RHS	10.3	2850	2590	2360	2150	1990	1860	1760	1660	
100x50x4.0RHS	8.49	2710	2410	2160	1970	1810	1670	1560	1460	
100x50x3.5RHS	7.53	2620	2290	2050	1840	1680	1540	1430	1340	
100x50x3.0RHS	6.60	2490	2110	1860	1670	1520	1400	1310	1220	
100x50x2.5RHS	5.56	2130	1790	1560	1390	1250	1150	1060	990	
100x50x2.0RHS	4.50	1650	1350	1160	1020	910	820	750	690	
75x50x5.0RHS	8.35	2230	2020	1870	1700	1580	1480	1390	1320	
75x50x4.0RHS	6.92	2120	1920	1720	1570	1450	1360	1270	1200	
75x50x3.0RHS	5.42	1990	1730	1550	1410	1310	1220	1130	1060	
75x50x2.5RHS	4.58	1840	1600	1430	1300	1180	1090	1010	950	
75x50x2.0RHS	3.72	1550	1310	1140	1020	920	850	780	730	
75x50x1.6RHS	3.01	1160	960	820	730	650	590	540	500	

*1 Trussed roof - effective roof width is assumed to be equal to 3 times effective floor width

* Additional web stiffeners are required if load bearing walls perpendicular to the bearer are supported at the end of the bearer (load from cross wall is assumed to be 2.1m of masonry tile roof and weight of the load bearing wall)

Maximum bearer span (mm)

Single span

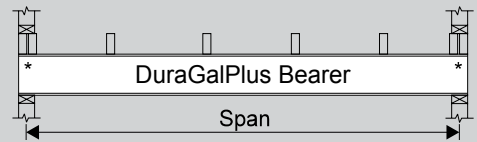

DuraGalPlus section	Mass kg/m	Effective Bearer Spacing (mm)							
		1800	2400	3000	3600	4200	4800	5400	6000
150x50x6.0RHS	16.7	3740	3400	3150	2970	2820	2700	2590	2500
150x50x5.0RHS	14.2	3580	3250	3020	2840	2700	2580	2480	2400
150x50x4.0RHS	11.6	3380	3070	2850	2680	2550	2440	2340	2260
150x50x3.0RHS	8.96	3140	2850	2650	2490	2370	2260	2180	2100
150x50x2.5RHS	7.53	2970	2700	2510	2360*	2240*	2140*	2060*	1990*
150x50x2.0RHS	6.07	2780*	2530*	2340*	1980*	1700*	1480*	1320*	1190*
125x75x6.0RHS	16.7	3500	3180	2960	2780	2640	2530	2430	2350
125x75x5.0RHS	14.2	3350	3050	2830	2660	2530	2420	2320	2240
125x75x4.0RHS	11.6	3160	2870	2670	2510	2380	2280	2190	2120
125x75x3.0RHS	8.96	2930	2660	2470	2320	2210	2110	2030	1960
125x75x2.5RHS	7.53	2770	2520	2340	2200	2090	2000*	1920*	1860*
125x75x2.0RHS	6.07	2590	2360*	2190*	2060*	1950*	1870*	1740*	1570*
100x50x5.0RHS	10.3	2510	2280	2120	1990	1890	1810	1740	1680
100x50x4.0RHS	8.49	2380	2160	2010	1890	1800	1720	1650	1590
100x50x3.5RHS	7.53	2300	2090	1940	1830	1740	1660	1600	1540
100x50x3.0RHS	6.60	2220	2020	1880	1770	1680	1600	1540	1490
100x50x2.5RHS	5.56	2110	1920	1780	1680	1590	1520	1470	1410
100x50x2.0RHS	4.50	1980	1800	1670	1570	1490*	1430*	1370*	1330*
75x50x5.0RHS	8.35	1960	1780	1650	1550	1480	1410	1360	1310
75x50x4.0RHS	6.92	1870	1700	1580	1480	1410	1350	1300	1250
75x50x3.0RHS	5.42	1750	1590	1480	1390	1320	1260	1220	1170
75x50x2.5RHS	4.58	1670	1520	1410	1320	1260	1200	1160	1120
75x50x2.0RHS	3.72	1570	1420	1320	1240	1180	1130	1090	1050
75x50x1.6RHS	3.01	1470	1330	1240	1160*	1110*	1060*	1020*	980*

*¹ Pitched roof - effective roof width is assumed to be equal to effective floor width

* Additional web stiffeners are required if load bearing walls perpendicular to the bearer are supported at the end of the bearer (load from cross wall is assumed to be 2.1m of masonry tile roof and weight of the load bearing wall)

Maximum bearer span (mm)

Continuous span

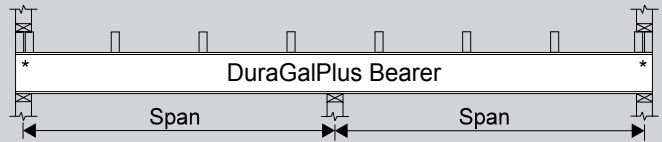

DuraGalPlus section	Mass kg/m	Effective Bearer Spacing (mm)							
		1800	2400	3000	3600	4200	4800	5400	6000
150x50x6.0RHS	16.7	4620	4200	3900	3670	3480	3330	3200	3090
150x50x5.0RHS	14.2	4430	4020	3730	3510	3340	3190	3070	2960
150x50x4.0RHS	11.6	4180	3800	3520	3320	3150	3010	2900	2800
150x50x3.0RHS	8.96	3880	3520	3240	2890	2610	2390	2210	2060
150x50x2.5RHS	7.53	3600	2970	2550	2240	2000*	1810*	1660*	1530*
150x50x2.0RHS	6.07	2480	1990*	1670*	1440*	1270*	1140*	1030*	940*
125x75x6.0RHS	16.7	4330	3930	3650	3440	3270	3120	3000	2900
125x75x5.0RHS	14.2	4140	3760	3490	3290	3120	2990	2870	2770
125x75x4.0RHS	11.6	3910	3550	3290	3100	2950	2820	2710	2610
125x75x3.0RHS	8.96	3620	3290	2950	2650	2410	2220	2070	1940
125x75x2.5RHS	7.53	3190	2680	2330	2070	1870	1710	1580	1470*
125x75x2.0RHS	6.07	2340	1930	1650*	1440*	1290*	1170*	1070*	980*
100x50x5.0RHS	10.3	3100	2820	2620	2460	2340	2240	2150	2080
100x50x4.0RHS	8.49	2940	2670	2480	2340	2220	2120	2040	1970
100x50x3.5RHS	7.53	2850	2590	2400	2260	2150	2050	1970	1910
100x50x3.0RHS	6.60	2750	2500	2320	2180	2070	1980	1910	1840
100x50x2.5RHS	5.56	2610	2370	2200	2070	1930	1780	1660	1550
100x50x2.0RHS	4.50	2450	2140	1850	1640	1480	1350*	1240*	1150*
75x50x5.0RHS	8.35	2420	2200	2040	1920	1820	1750	1680	1620
75x50x4.0RHS	6.92	2310	2100	1950	1830	1740	1660	1600	1550
75x50x3.0RHS	5.42	2170	1970	1830	1720	1630	1560	1500	1450
75x50x2.5RHS	4.58	2060	1870	1740	1640	1560	1490	1430	1380
75x50x2.0RHS	3.72	1940	1760	1630	1540	1410	1300	1210	1140
75x50x1.6RHS	3.01	1780	1490	1300	1150	1040*	950*	880*	820*

*¹ Pitched roof - effective roof width is assumed to be equal to effective floor width

* Additional web stiffeners are required if load bearing walls perpendicular to the bearer are supported at the end of the bearer (load from cross wall is assumed to be 2.1m of masonry tile roof and weight of the load bearing wall)

Maximum bearer span (mm)

Single span

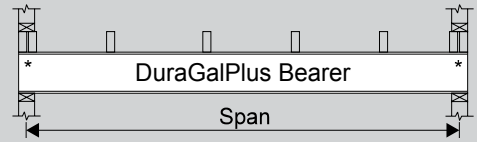

DuraGalPlus section	Mass kg/m	Effective Bearer Spacing (mm)							
		1800	2400	3000	3600	4200	4800	5400	6000
150x50x6.0RHS	16.7	3740	3400	3150	2970	2820	2700	2590	2500
150x50x5.0RHS	14.2	3580	3250	3020	2840	2700	2580	2480	2400
150x50x4.0RHS	11.6	3380	3070	2850	2680	2550	2440	2340	2260
150x50x3.0RHS	8.96	3140	2850	2650	2490	2370	2260	2180*	2100*
150x50x2.5RHS	7.53	2970	2700	2510*	2360*	2240*	2140*	2060*	1860*
150x50x2.0RHS	6.07	2780*	2350*	1890*	1570*	1350*	1180*	1050*	950*
125x75x6.0RHS	16.7	3500	3180	2960	2780	2640	2530	2430	2350
125x75x5.0RHS	14.2	3350	3050	2830	2660	2530	2420	2320	2240
125x75x4.0RHS	11.6	3160	2870	2670	2510	2380	2280	2190	2120
125x75x3.0RHS	8.96	2930	2660	2470	2320	2210	2110	2030	1960
125x75x2.5RHS	7.53	2770	2520	2340	2200	2090*	2000*	1920*	1860*
125x75x2.0RHS	6.07	2590	2360*	2190*	2060*	1780*	1560*	1390*	1250*
100x50x5.0RHS	10.3	2510	2280	2120	1990	1890	1810	1740	1680
100x50x4.0RHS	8.49	2380	2160	2010	1890	1800	1720	1650	1590
100x50x3.5RHS	7.53	2300	2090	1940	1830	1740	1660	1600	1540
100x50x3.0RHS	6.60	2220	2020	1880	1770	1680	1600	1540	1490
100x50x2.5RHS	5.56	2110	1920	1780	1680	1590	1520	1470	1410
100x50x2.0RHS	4.50	1980	1800	1670	1570*	1490*	1430*	1370*	1330*
75x50x5.0RHS	8.35	1960	1780	1650	1550	1480	1410	1360	1310
75x50x4.0RHS	6.92	1870	1700	1580	1480	1410	1350	1300	1250
75x50x3.0RHS	5.42	1750	1590	1480	1390	1320	1260	1220	1170
75x50x2.5RHS	4.58	1670	1520	1410	1320	1260	1200	1160	1120
75x50x2.0RHS	3.72	1570	1420	1320	1240	1180	1130	1090	1050
75x50x1.6RHS	3.01	1470	1330	1240	1160*	1110*	1060*	1010*	960*

*¹ Trussed roof - effective roof width is assumed to be equal to 3 times effective floor width

* Additional web stiffeners are required if load bearing walls perpendicular to the bearer are supported at the end of the bearer (load from cross wall is assumed to be 2.1m of masonry tile roof and weight of the load bearing wall)

Maximum bearer span (mm)

Continuous span

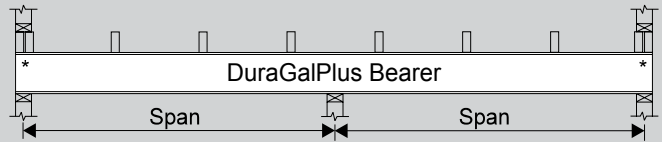

DuraGalPlus section	Mass kg/m	Effective Bearer Spacing (mm)							
		1800	2400	3000	3600	4200	4800	5400	6000
150x50x6.0RHS	16.7	4620	4200	3900	3670	3440	3220	3040	2080
150x50x5.0RHS	14.2	4430	4020	3730	3460	3200	3000	2820	2650
150x50x4.0RHS	11.6	4180	3800	3340	3010	2750	2540	2360	2220
150x50x3.0RHS	8.96	3430	2860	2470	2190	1970	1800	1650	1530
150x50x2.5RHS	7.53	2710	2220	1880	1840	1460	1310	1200	1100
150x50x2.0RHS	6.07	1800	1400	1120	930	800	700	620	560
125x75x6.0RHS	16.7	4330	3930	3650	3440	3270	3120	2830	2660
125x75x5.0RHS	14.2	4140	3760	3490	3240	2960	2740	2560	2400
125x75x4.0RHS	11.6	3910	3550	3180	2860	2610	2410	2240	2100
125x75x3.0RHS	8.96	3480	2630	2290	2050	1860	1710	1560	1480
125x75x2.5RHS	7.53	2420	2050	1770	1570	1410	1280	1180	1100
125x75x2.0RHS	6.07	1760	1430	1210	1060	940	840	770	700
100x50x5.0RHS	10.3	3100	2820	2620	2460	2280	2130	2010	1010
100x50x4.0RHS	8.49	2940	2670	2470	2250	2090	1950	1830	1720
100x50x3.5RHS	7.53	2850	2590	2340	2130	1970	1820	1690	1580
100x50x3.0RHS	6.60	2750	2460	2160	1950	1780	1650	1540	1440
100x50x2.5RHS	5.56	2490	2100	1840	1640	1490	1370	1270	1180
100x50x2.0RHS	4.50	1960	1620	1400	1230	1100	1000	920	850
75x50x5.0RHS	8.35	2420	2200	2040	1920	1800	1690	1590	1510
75x50x4.0RHS	6.92	2310	2100	1950	1790	1660	1550	1470	1390
75x50x3.0RHS	5.42	2170	1970	1770	1610	1490	1400	1320	1250
75x50x2.5RHS	4.58	2060	1820	1630	1490	1380	1280	1200	1120
75x50x2.0RHS	3.72	1820	1540	1340	1200	1090	1000	930	870
75x50x1.6RHS	3.01	1370	1140	990	870	780	710	660	610

*¹ Trussed roof - effective roof width is assumed to be equal to 3 times effective floor width

* Additional web stiffeners are required if load bearing walls perpendicular to the bearer are supported at the end of the bearer (load from cross wall is assumed to be 2.1m of masonry tile roof and weight of the load bearing wall)

Maximum bearer span (mm)

Single span

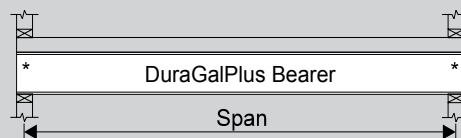

DuraGalPlus section	Mass kg/m	Effective Bearer Spacing (mm)							
		1800	2400	3000	3600	4200	4800	5400	6000
150x50x6.0RHS	16.7	3260	2970	2760	2590	2470	2360	2270	2190
150x50x5.0RHS	14.2	3120	2840	2640	2490	2360	2260	2170	2100
150x50x4.0RHS	11.6	2950	2680	2490	2350	2230	2130	2050	1980
150x50x3.0RHS	8.96	2740	2490	2310	2180	2070*	1980*	1900*	1840*
150x50x2.5RHS	7.53	2600	2360*	2190*	1980*	1700*	1490*	1320*	1190*
150x50x2.0RHS	6.07	2010*	1510*	1210*	1010*	860*	760*	670*	600*
125x75x6.0RHS	16.7	3050	2780	2580	2430	2310	2210	2130	2050
125x75x5.0RHS	14.2	2920	2660	2470	2330	2210	2110	2030	1960
125x75x4.0RHS	11.6	2760	2510	2330	2190	2090	1990	1920	1850
125x75x3.0RHS	8.96	2560	2330	2160	2030	1930	1850	1780	1720
125x75x2.5RHS	7.53	2430	2210	2050	1930*	1830*	1750*	1650*	1570*
125x75x2.0RHS	6.07	2270*	1990*	1590*	1330*	1140*	1000*	890*	800*
100x50x5.0RHS	10.3	2190	1990	1850	1740	1660	1580	1520	1470
100x50x4.0RHS	8.49	2080	1890	1760	1650	1570	1500	1450	1400
100x50x3.5RHS	7.53	2010	1830	1700	1600	1520	1450	1400	1350
100x50x3.0RHS	6.60	1950	1770	1640	1550	1470	1400	1350	1300
100x50x2.5RHS	5.56	1850	1680	1560	1470	1400	1330	1280	1240*
100x50x2.0RHS	4.50	1730	1570	1460*	1380*	1310*	1250*	1200*	1130*
75x50x5.0RHS	8.35	1710	1560	1450	1360	1290	1240	1190	1150
75x50x4.0RHS	6.92	1630	1480	1380	1300	1230	1180	1130	1100
75x50x3.0RHS	5.42	1530	1390	1300	1220	1160	1110	1070	1030
75x50x2.5RHS	4.58	1460	1330	1230	1160	1100	1050	1010	980
75x50x2.0RHS	3.72	1370	1250	1160	1090	1030	990	950	910*
75x50x1.6RHS	3.01	1280	1170	1080*	990*	910*	850*	810*	760*

*¹ Pitched roof - effective roof width is assumed to be equal to effective floor width

* Additional web stiffeners are required if load bearing walls perpendicular to the bearer are supported at the end of the bearer (load from cross wall is assumed to be 2.1m of masonry tile roof and weight of the load bearing wall)

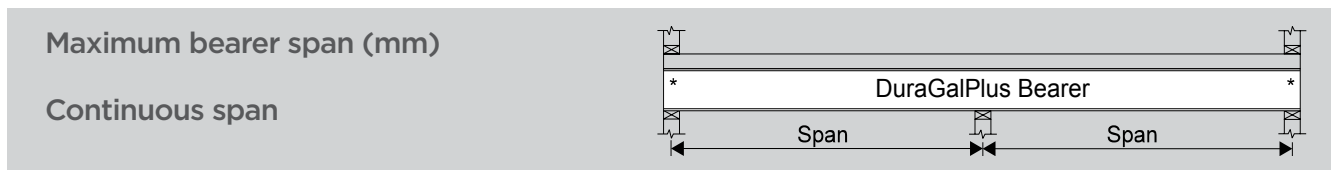

DuraGalPlus section	Mass kg/m	Effective Bearer Spacing (mm)							
		1800	2400	3000	3600	4200	4800	5400	6000
150x50x6.0RHS	16.7	4030	3660	3400	3210	3030	2830	2670	2520
150x50x5.0RHS	14.2	3860	3510	3260	3040	2810	2600	2420	2270
150x50x4.0RHS	11.6	3650	3280	2880	2580	2360	2170	2020	1890
150x50x3.0RHS	8.96	2920	2420	2080	1830	1650	1500	1370	1270
150x50x2.5RHS	7.53	2260	1830	1550	1350*	1190*	1070*	970*	890*
150x50x2.0RHS	6.07	1410*	1120*	940*	810*	710*	630*	570*	510*
125x75x6.0RHS	16.7	3770	3430	3190	3000	2820	2610	2430	2290
125x75x5.0RHS	14.2	3610	3290	3050	2790	2550	2350	2190	2060
125x75x4.0RHS	11.6	3410	3100	2740	2450	2240	2060	1910	1790
125x75x3.0RHS	8.96	2670	2250	1960	1740	1580	1440	1340	1240
125x75x2.5RHS	7.53	2090	1730	1490	1310	1180	1070	980*	910*
125x75x2.0RHS	6.07	1420	1170	990*	860*	760*	680*	620*	570*
100x50x5.0RHS	10.3	2710	2460	2290	2150	2000	1870	1770	1670
100x50x4.0RHS	8.49	2570	2340	2170	1980	1820	1680	1560	1470
100x50x3.5RHS	7.53	2490	2260	2060	1850	1680	1550	1440	1350
100x50x3.0RHS	6.60	2400	2120	1870	1680	1530	1410	1310	1230
100x50x2.5RHS	5.56	2140	1800	1570	1400	1260	1160	1070	1000
100x50x2.0RHS	4.50	1650	1360	1170	1020	910*	830*	760*	700*
75x50x5.0RHS	8.35	2110	1920	1790	1680	1580	1480	1400	1330
75x50x4.0RHS	6.92	2020	1830	1700	1580	1460	1370	1280	1200
75x50x3.0RHS	5.42	1900	1720	1550	1420	1310	1220	1140	1070
75x50x2.5RHS	4.58	1800	1600	1440	1310	1190	1100	1020	960
75x50x2.0RHS	3.72	1550	1320	1150	1020	930	850	790	730
75x50x1.6RHS	3.01	1070	910	790	710*	640*	590*	540*	500*

*¹ Pitched roof - effective roof width is assumed to be equal to effective floor width

* Additional web stiffeners are required if load bearing walls perpendicular to the bearer are supported at the end of the bearer (load from cross wall is assumed to be 2.1m of masonry tile roof and weight of the load bearing wall)

Maximum bearer span (mm)

Single span

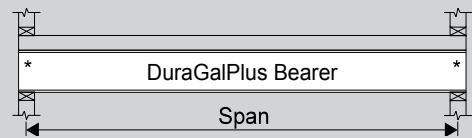

DuraGalPlus section	Mass kg/m	Effective Bearer Spacing (mm)							
		1800	2400	3000	3600	4200	4800	5400	6000
150x50x6.0RHS	16.7	2940	2670	2480	2340	2220	2130	2050	1970
150x50x5.0RHS	14.2	2820	2560	2380	2240	2130	2040	1960	1890
150x50x4.0RHS	11.6	2660	2420	2250	2120	2010	1920	1850	1790
150x50x3.0RHS	8.96	2470	2250	2090	1960*	1870*	1790*	1720*	1600*
150x50x2.5RHS	7.53	2340*	2130*	1840*	1530*	1310*	1150*	1020*	920*
150x50x2.0RHS	6.07	1530*	1150*	920*	770*	660*	570*	510*	460*
125x75x6.0RHS	16.7	2760	2510	2330	2190	2080	1990	1920	1850
125x75x5.0RHS	14.2	2640	2400	2230	2100	1990	1910	1830	1770
125x75x4.0RHS	11.6	2490	2260	2100	1980	1880	1800	1730	1670
125x75x3.0RHS	8.96	2310	2100	1950	1830	1740	1670	1600*	1550*
125x75x2.5RHS	7.53	2190	1990	1850*	1740*	1650*	1510*	1350*	1210*
125x75x2.0RHS	6.07	2040*	1540*	1230*	1030*	880*	770*	690*	620*
100x50x5.0RHS	10.3	1980	1800	1670	1570	1490	1430	1370	1330
100x50x4.0RHS	8.49	1880	1710	1580	1490	1420	1360	1300	1260
100x50x3.5RHS	7.53	1820	1650	1530	1440	1370	1310	1260	1220
100x50x3.0RHS	6.60	1750	1590	1480	1390	1320	1270	1220	1180
100x50x2.5RHS	5.56	1670	1510	1410	1320	1260	1200	1160*	1110*
100x50x2.0RHS	4.50	1560	1420	1320*	1240*	1180*	1090*	970*	870*
75x50x5.0RHS	8.35	1540	1400	1300	1230	1160	1110	1070	1030
75x50x4.0RHS	6.92	1470	1340	1240	1170	1110	1060	1020	990
75x50x3.0RHS	5.42	1380	1260	1170	1100	1040	1000	960	930
75x50x2.5RHS	4.58	1320	1200	1110	1050	990	950	910	880
75x50x2.0RHS	3.72	1240	1120	1040	980	930	890	850*	800*
75x50x1.6RHS	3.01	1160	1040*	940*	870*	800*	750*	710*	670*

*¹ Trussed roof - effective roof width is assumed to be equal to 3 times effective floor width

* Additional web stiffeners are required if load bearing walls perpendicular to the bearer are supported at the end of the bearer (load from cross wall is assumed to be 2.1m of masonry tile roof and weight of the load bearing wall)

Maximum bearer span (mm)

Continuous span

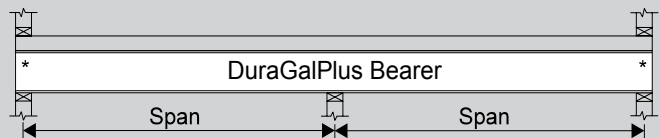

DuraGalPlus section	Mass kg/m	Effective Bearer Spacing (mm)							
		1800	2400	3000	3600	4200	4800	5400	6000
150x50x6.0RHS	16.7	3630	3310	3020	2760	2550	2360	2190	2050
150x50x5.0RHS	14.2	3480	3140	2810	2530	2300	2110	1980	1840
150x50x4.0RHS	11.6	3200	2700	2360	2110	1920	1760	1640	1530
150x50x3.0RHS	8.96	2350	1930	1650	1440	1290	1170	1070	980
150x50x2.5RHS	7.53	1770	1420	1190	1020	870	760	680	610
150x50x2.0RHS	6.07	1030	780	620	520	440	390	340	310
125x75x6.0RHS	16.7	3400	3100	2830	2540	2320	2140	1990	1870
125x75x5.0RHS	14.2	3260	2910	2550	2290	2080	1920	1790	1670
125x75x4.0RHS	11.6	3040	2560	2240	2000	1820	1670	1530	1440
125x75x3.0RHS	8.96	2180	1820	1580	1400	1260	1150	1060	990
125x75x2.5RHS	7.53	1680	1380	1180	1030	920	830	760	700
125x75x2.0RHS	6.07	1130	910	760	660	570	500	440	400
100x50x5.0RHS	10.3	2440	2220	2000	1830	1690	1560	1450	1360
100x50x4.0RHS	8.49	2320	2050	1820	1630	1480	1370	1270	1180
100x50x3.5RHS	7.53	2240	1930	1690	1510	1370	1250	1160	1090
100x50x3.0RHS	6.60	2070	1750	1530	1370	1250	1150	1070	1000
100x50x2.5RHS	5.56	1750	1460	1260	1120	1010	920	850	790
100x50x2.0RHS	4.50	1320	1080	910	800	710	640	580	530
75x50x5.0RHS	8.35	1910	1730	1580	1450	1340	1250	1180	1110
75x50x4.0RHS	6.92	1820	1630	1460	1330	1220	1120	1040	980
75x50x3.0RHS	5.42	1690	1470	1310	1190	1080	1000	920	870
75x50x2.5RHS	4.58	1560	1360	1190	1060	970	890	820	770
75x50x2.0RHS	3.72	1280	1070	930	820	740	680	630	580
75x50x1.6RHS	3.01	890	740	640	520	510	460	420	390

*1 Trussed roof - effective roof width is assumed to be equal to 3 times effective floor width

* Additional web stiffeners are required if load bearing walls perpendicular to the bearer are supported at the end of the bearer (load from cross wall is assumed to be 2.1m of masonry tile roof and weight of the load bearing wall)

Maximum bearer span (mm)

Single span

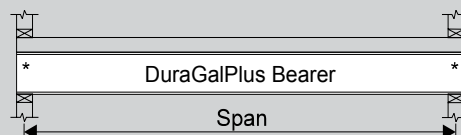

DuraGalPlus section	Mass kg/m	Effective Bearer Spacing (mm)							
		1800	2400	3000	3600	4200	4800	5400	6000
150x50x6.0RHS	16.7	3380	3070	2850	2690	2550	2440	2350	2270
150x50x5.0RHS	14.2	3240	2940	2730	2580	2450	2340	2250	2170
150x50x4.0RHS	11.6	3060	2780	2580	2430	2310	2210	2130	2050
150x50x3.0RHS	8.96	2840	2580	2400	2260	2150	2050*	1970*	1910*
150x50x2.5RHS	7.53	2690	2450*	2270*	2140*	1850*	1620*	1440*	1300*
150x50x2.0RHS	6.07	2190*	1640*	1320*	1100*	940*	820*	730*	660*
125x75x6.0RHS	16.7	3160	2880	2670	2520	2390	2290	2200	2130
125x75x5.0RHS	14.2	3030	2750	2560	2410	2290	2190	2110	2040
125x75x4.0RHS	11.6	2860	2600	2420	2270	2160	2070	1990	1920
125x75x3.0RHS	8.96	2650	2410	2240	2110	2000	1920	1840	1780
125x75x2.5RHS	7.53	2510	2290	2120	2000*	1900*	1820*	1720*	1630*
125x75x2.0RHS	6.07	2350*	2140*	1740*	1450*	1240*	1090*	970*	870*
100x50x5.0RHS	10.3	2270	2060	1920	1810	1720	1640	1580	1520
100x50x4.0RHS	8.49	2160	1960	1820	1710	1630	1560	1500	1450
100x50x3.5RHS	7.53	2090	1900	1760	1660	1580	1510	1450	1400
100x50x3.0RHS	6.60	2020	1830	1700	1600	1520	1460	1400	1350
100x50x2.5RHS	5.56	1920	1740	1620	1520	1450	1380	1330	1280
100x50x2.0RHS	4.50	1800	1630	1520*	1430*	1350*	1300*	1250*	1180*
75x50x5.0RHS	8.35	1770	1610	1500	1410	1340	1280	1230	1190
75x50x4.0RHS	6.92	1690	1540	1430	1350	1280	1220	1180	1140
75x50x3.0RHS	5.42	1590	1450	1340	1260	1200	1150	1100	1070
75x50x2.5RHS	4.58	1510	1380	1280	1200	1140	1090	1050	1010
75x50x2.0RHS	3.72	1420	1290	1200	1130	1070	1030	990	950*
75x50x1.6RHS	3.01	1330	1210	1120*	1030*	950*	890*	840*	800*

*¹ Pitched roof - effective roof width is assumed to be equal to effective floor width

* Additional web stiffeners are required if load bearing walls perpendicular to the bearer are supported at the end of the bearer (load from cross wall is assumed to be 2.1m of masonry tile roof and weight of the load bearing wall)

Maximum bearer span (mm)

Continuous span



DuraGalPlus section	Mass kg/m	Effective Bearer Spacing (mm)							
		1800	2400	3000	3600	4200	4800	5400	6000
150x50x6.0RHS	16.7	4170	3800	3530	3320	3160	2960	2790	2650
150x50x5.0RHS	14.2	4000	3640	3380	3170	2940	2730	2550	2390
150x50x4.0RHS	11.6	3780	3440	3030	2720	2480	2290	2130	2000
150x50x3.0RHS	8.96	3080	2560	2200	1950	1750	1590	1460	1350
150x50x2.5RHS	7.53	2410	1950	1650	1440*	1280*	1150*	1040*	960*
150x50x2.0RHS	6.07	1540*	1230*	1020*	870*	760*	680*	610*	560*
125x75x6.0RHS	16.7	3910	3560	3310	3110	2960	2740	2560	2410
125x75x5.0RHS	14.2	3740	3400	3160	2930	2680	2480	2310	2170
125x75x4.0RHS	11.6	3530	3210	2880	2580	2350	2170	2020	1890
125x75x3.0RHS	8.96	2810	2370	2060	1840	1670	1530	1410	1320
125x75x2.5RHS	7.53	2210	1830	1580	1390	1250	1140	1040	970*
125x75x2.0RHS	6.07	1530	1260	1060*	920*	820*	730*	670*	610*
100x50x5.0RHS	10.3	2810	2550	2370	2230	2090	1950	1840	1750
100x50x4.0RHS	8.49	2670	2420	2250	2070	1920	1770	1650	1550
100x50x3.5RHS	7.53	2580	2340	2140	1950	1780	1640	1520	1420
100x50x3.0RHS	6.60	2490	2230	1960	1760	1610	1490	1380	1300
100x50x2.5RHS	5.56	2250	1900	1650	1470	1340	1220	1130	1060
100x50x2.0RHS	4.50	1750	1450	1240	1090	970*	880*	810*	750*
75x50x5.0RHS	8.35	2190	1990	1850	1740	1650	1550	1460	1380
75x50x4.0RHS	6.92	2090	1900	1770	1650	1520	1430	1340	1270
75x50x3.0RHS	5.42	1960	1790	1620	1480	1370	1280	1200	1120
75x50x2.5RHS	4.58	1870	1670	1500	1370	1250	1160	1080	1010
75x50x2.0RHS	3.72	1640	1390	1210	1080	980	900	830	780
75x50x1.6RHS	3.01	1140	970	850	760*	690*	630*	580*	540*

*¹ Pitched roof - effective roof width is assumed to be equal to effective floor width

* Additional web stiffeners are required if load bearing walls perpendicular to the bearer are supported at the end of the bearer (load from cross wall is assumed to be 2.1m of masonry tile roof and weight of the load bearing wall)

Maximum bearer span (mm)

Single span

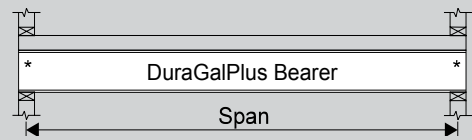

DuraGalPlus section	Mass kg/m	Effective Bearer Spacing (mm)							
		1800	2400	3000	3600	4200	4800	5400	6000
150x50x6.0RHS	16.7	3200	2910	2700	2540	2420	2310	2220	2150
150x50x5.0RHS	14.2	3060	2790	2590	2440	2320	2220	2130	2060
150x50x4.0RHS	11.6	2890	2630	2440	2300	2190	2090	2010	1940
150x50x3.0RHS	8.96	2690	2440	2270	2140	2030*	1940*	1870*	1800*
150x50x2.5RHS	7.53	2550	2320*	2150*	1890*	1620*	1420*	1260*	1140*
150x50x2.0RHS	6.07	1920*	1440*	1150*	960*	820*	720*	640*	580*
125x75x6.0RHS	16.7	2990	2720	2530	2380	2260	2170	2080	2010
125x75x5.0RHS	14.2	2870	2610	2420	2280	2170	2070	1990	1930
125x75x4.0RHS	11.6	2710	2460	2290	2150	2040	1960	1880	1820
125x75x3.0RHS	8.96	2510	2280	2120	1990	1890	1810	1740	1680*
125x75x2.5RHS	7.53	2380	2160	2010	1890*	1800*	1710*	1610*	1500*
125x75x2.0RHS	6.07	2220*	1900*	1520*	1270*	1090*	950*	850*	760*
100x50x5.0RHS	10.3	2150	1950	1810	1710	1620	1550	1490	1440
100x50x4.0RHS	8.49	2040	1860	1720	1620	1540	1470	1420	1370
100x50x3.5RHS	7.53	1970	1790	1670	1570	1490	1430	1370	1320
100x50x3.0RHS	6.60	1910	1730	1610	1520	1440	1380	1320	1280
100x50x2.5RHS	5.56	1810	1650	1530	1440	1370	1310	1260	1210*
100x50x2.0RHS	4.50	1700	1540	1430*	1350*	1280*	1230*	1170*	1080*
75x50x5.0RHS	8.35	1680	1530	1420	1330	1270	1210	1170	1130
75x50x4.0RHS	6.92	1600	1460	1350	1270	1210	1160	1110	1070
75x50x3.0RHS	5.42	1500	1370	1270	1200	1140	1090	1040	1010
75x50x2.5RHS	4.58	1430	1300	1210	1140	1080	1030	990	960
75x50x2.0RHS	3.72	1340	1220	1130	1070	1010	970	930	890*
75x50x1.6RHS	3.01	1260	1140	1060*	960*	890*	830*	790*	750*

*¹ Trussed roof - effective roof width is assumed to be equal to 3 times effective floor width

* Additional web stiffeners are required if load bearing walls perpendicular to the bearer are supported at the end of the bearer (load from cross wall is assumed to be 2.1m of masonry tile roof and weight of the load bearing wall)

Maximum bearer span (mm)

Continuous span



DuraGalPlus section	Mass kg/m	Effective Bearer Spacing (mm)							
		1800	2400	3000	3600	4200	4800	5400	6000
150x50x6.0RHS	16.7	3950	3590	3310	3030	2800	2620	2450	2300
150x50x5.0RHS	14.2	3780	3440	3080	2810	2570	2360	2200	2060
150x50x4.0RHS	11.6	3540	3000	2630	2360	2150	1980	1840	1720
150x50x3.0RHS	8.96	2640	2180	1870	1650	1470	1340	1220	1130
150x50x2.5RHS	7.53	2030	1630	1380	1190	1050	920	810	730
150x50x2.0RHS	6.07	1240	930	740	620	530	470	410	370
125x75x6.0RHS	16.7	3050	3370	3130	2820	2580	2380	2220	2090
125x75x5.0RHS	14.2	3540	3220	2840	2550	2320	2150	2000	1870
125x75x4.0RHS	11.6	3340	2850	2500	2240	2030	1870	1740	1620
125x75x3.0RHS	8.96	2440	2040	1770	1580	1420	1300	1200	1120
125x75x2.5RHS	7.53	1890	1560	1340	1180	1050	950	870	810
125x75x2.0RHS	6.07	1310	1050	880	760	670	600	530	480
100x50x5.0RHS	10.3	2660	2410	2190	2000	1850	1730	1620	1520
100x50x4.0RHS	8.49	2520	2250	2010	1820	1660	1530	1420	1330
100x50x3.5RHS	7.53	2440	2130	1880	1680	1530	1410	1310	1220
100x50x3.0RHS	6.60	2290	1940	1700	1530	1390	1290	1200	1120
100x50x2.5RHS	5.56	1950	1640	1420	1260	1140	1050	970	900
100x50x2.0RHS	4.50	1490	1220	1040	910	810	740	670	620
75x50x5.0RHS	8.35	2070	1890	1740	1580	1470	1370	1290	1230
75x50x4.0RHS	6.92	1980	1790	1600	1460	1350	1250	1170	1090
75x50x3.0RHS	5.42	1860	1610	1440	1310	1200	1110	1040	970
75x50x2.5RHS	4.58	1720	1490	1330	1190	1080	1000	930	870
75x50x2.0RHS	3.72	1430	1200	1040	930	840	770	710	660
75x50x1.6RHS	3.01	1030	870	740	650	590	530	400	450

*¹ Trussed roof - effective roof width is assumed to be equal to 3 times effective floor width

* Additional web stiffeners are required if load bearing walls perpendicular to the bearer are supported at the end of the bearer (load from cross wall is assumed to be 2.1m of masonry tile roof and weight of the load bearing wall)



Address Industrial Drive, Mayfield NSW 2304 | PO Box 156, Newcastle NSW 2300, Australia

Phone 1800 281 424 | **Fax** +61 7 3909 6660

Web www.austubemills.com.au

This publication has been prepared as a guide only to assist anyone that may specify or use the products described in this publication. Accordingly, while Austube Mills has endeavoured to ensure that all information provided in this publication is accurate and up-to-date, the following must be noted: this publication does not take into account any individual circumstances and is therefore not a substitute for informed or professional individual advice; the specifications and technical data relating to the products described in this publication are approximate and subject to change without notice, and users should check the currency of the information before relying upon it; and unless required by law, Austube Mills does not accept any responsibility for any loss, damage or consequence resulting from the contents of this publication or from any omission of information in this publication. © Copyright Austube Mills Pty Ltd. DuraGal, DuraGalPlus, the Austube Mills logo and the Australian Map of tubes are registered trade marks of Austube Mills Pty Ltd. Issue January 2017. TS3013.